

# legris

## transair

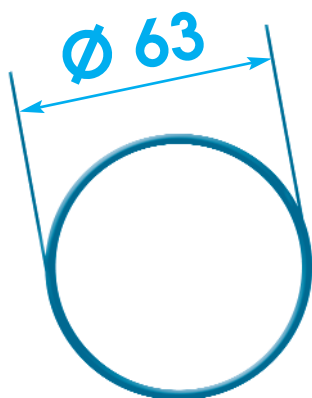

Notice de montage  
Assembly guide  
Montageanweisungen  
Guia de montaje  
Guida di montaggio  
Montagehandleiding  
Montageanvisningar  
Guia de Montagem



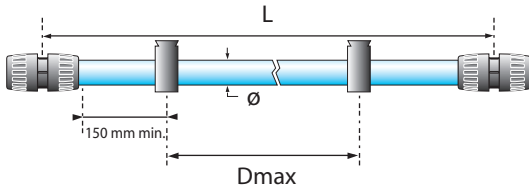

$\varnothing$	L (m)	$D_{max}$ (m)
63	3	2,5
63	6	4

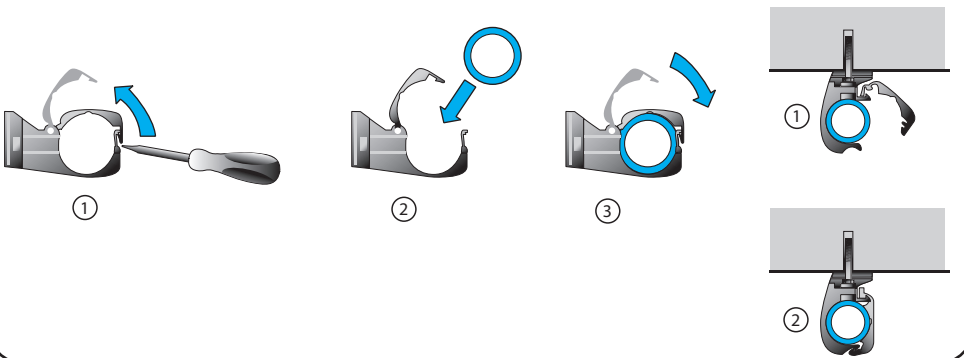
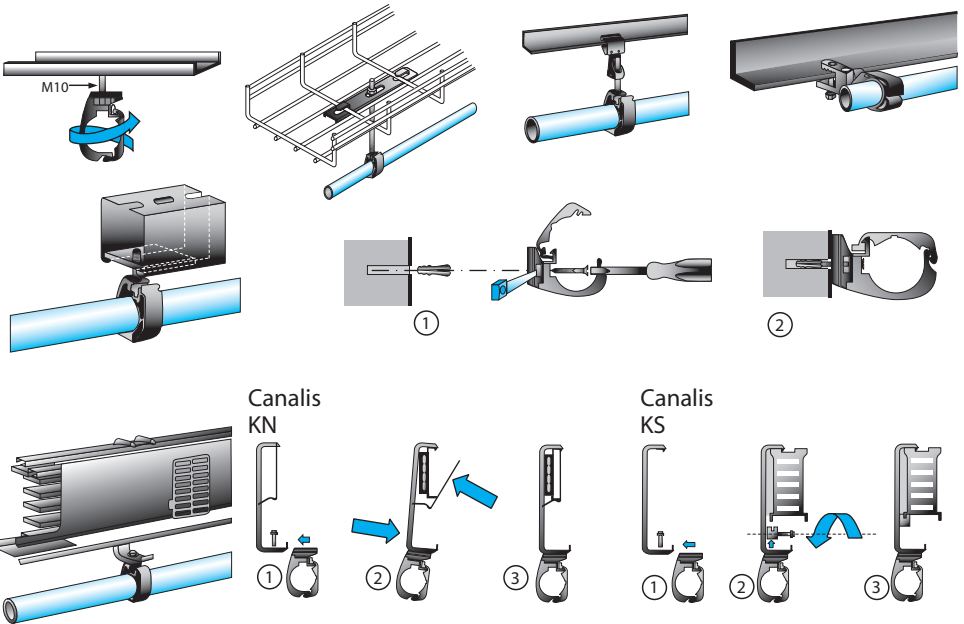

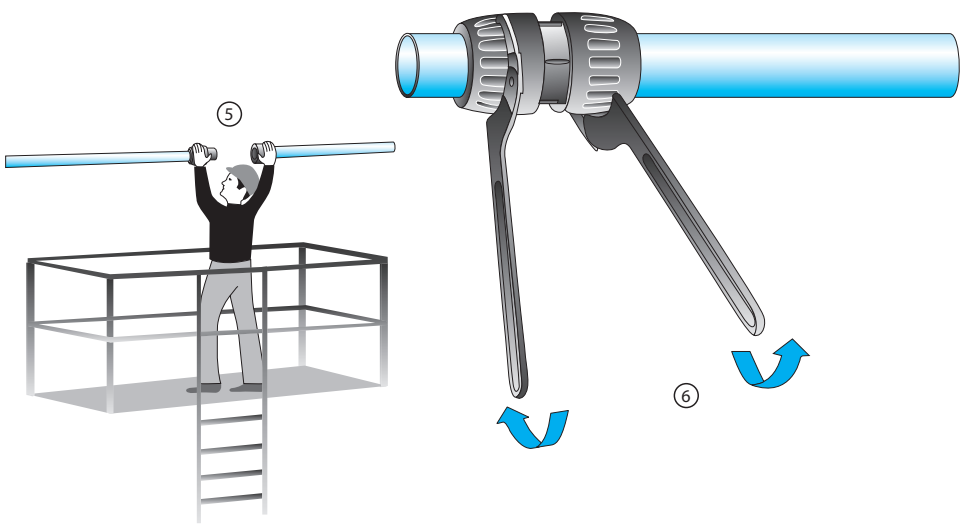
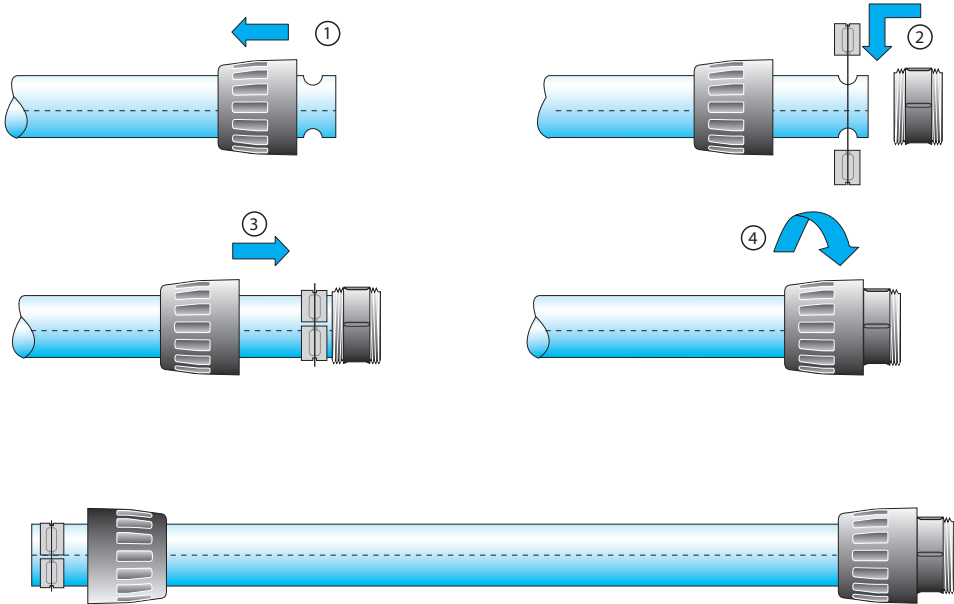

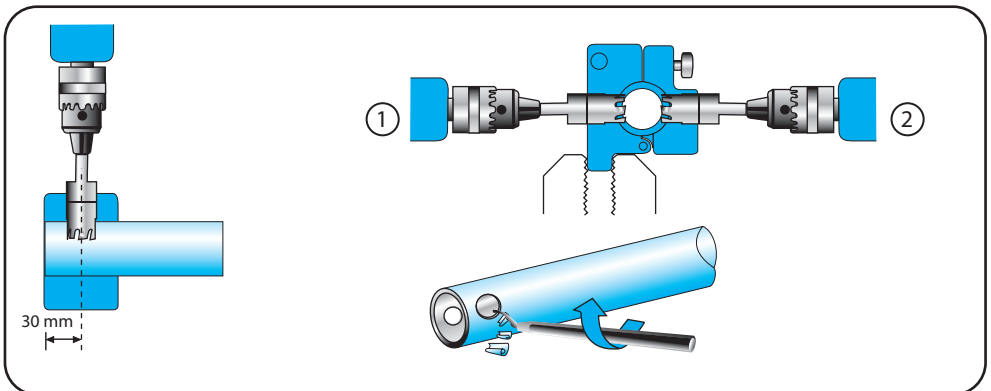
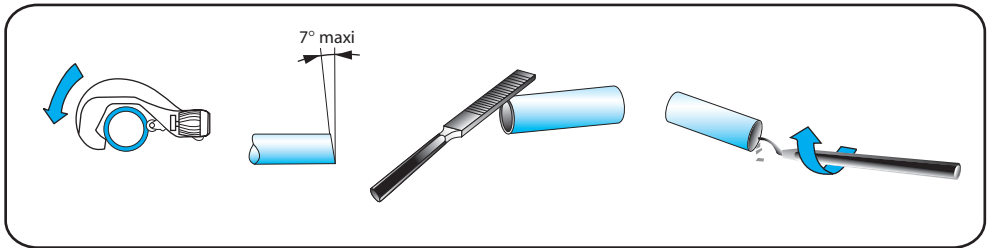
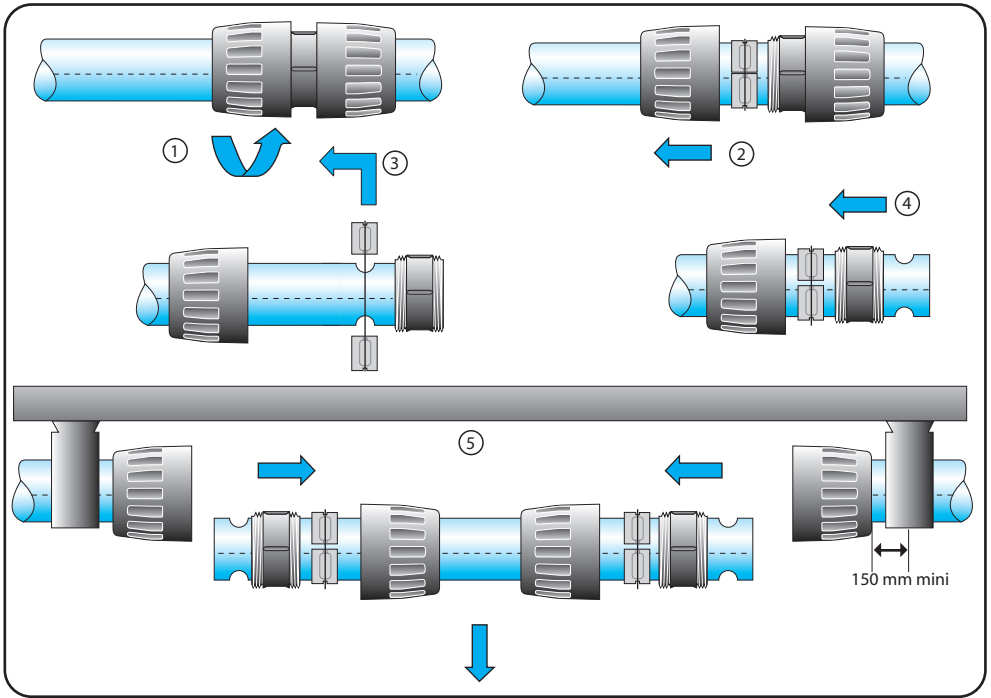

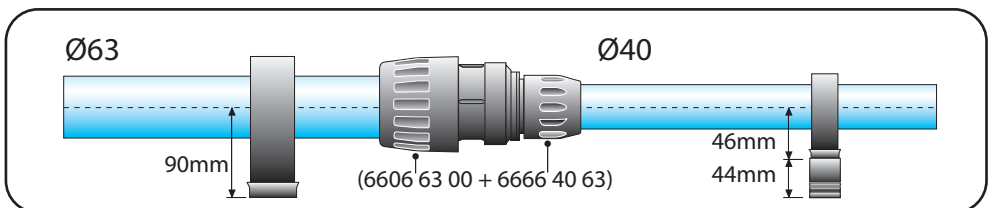
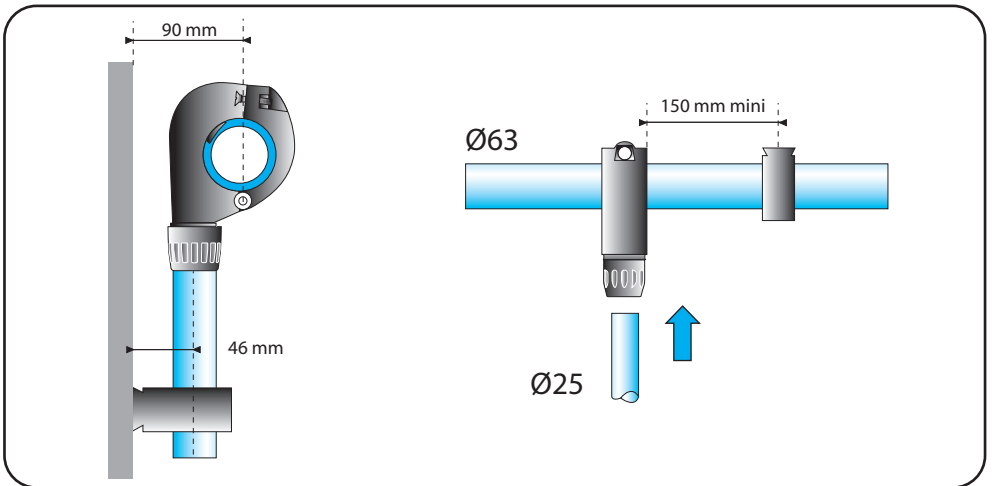
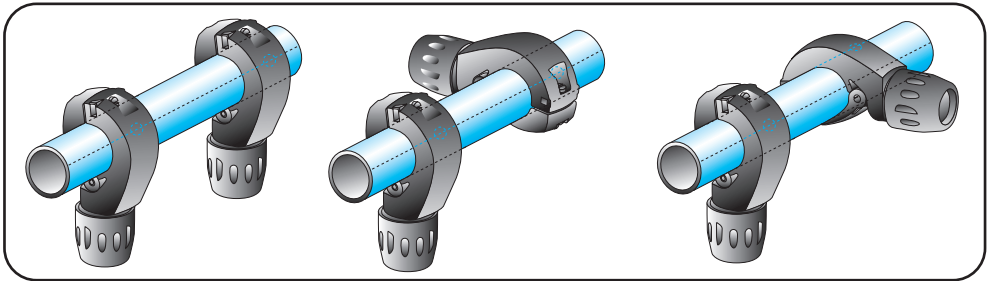
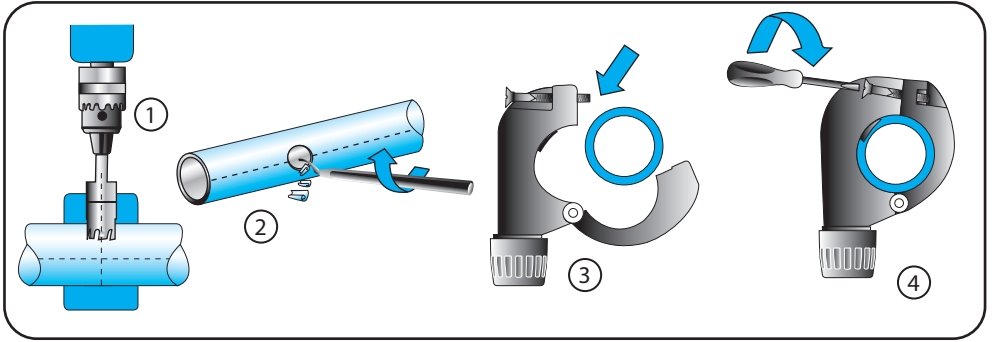

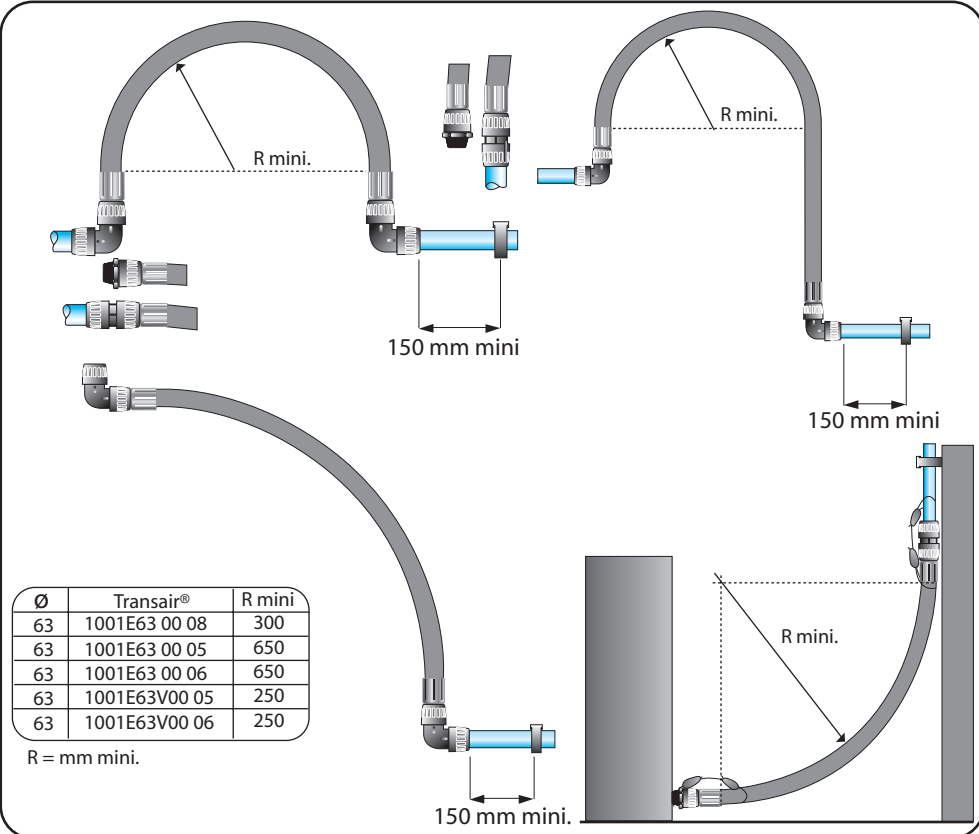
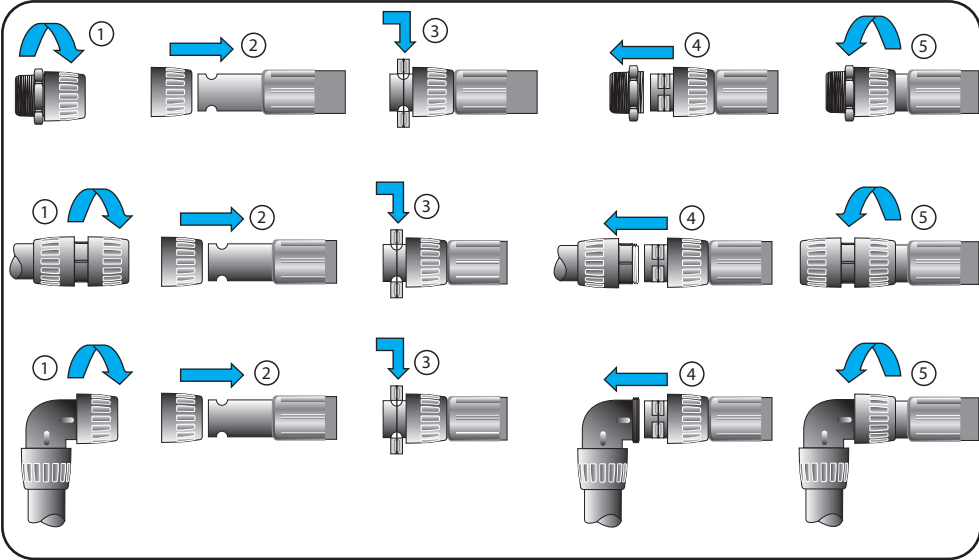

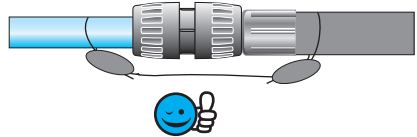
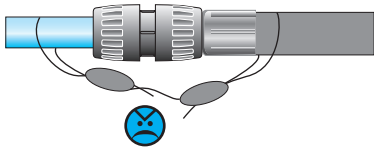
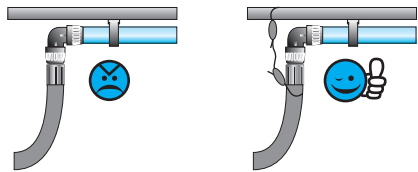
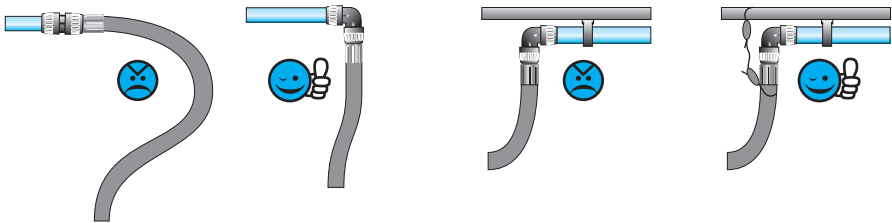
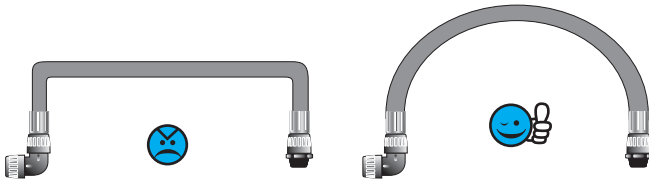
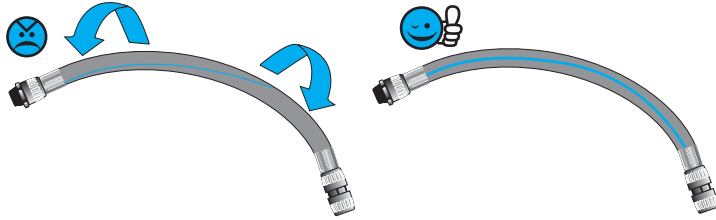
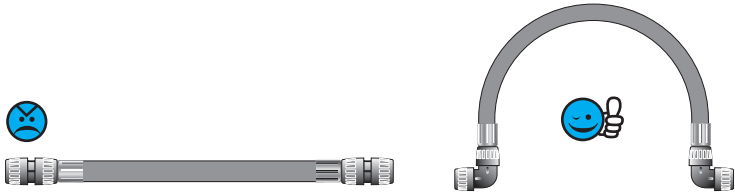

Ø63 mm

$$\Delta L = (0,2 \times L) + (0,024 \times L \times \Delta T)$$

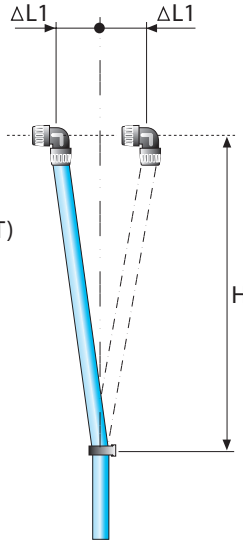

Ø	H (m)	ΔL1 (mm)
63	0,75	15

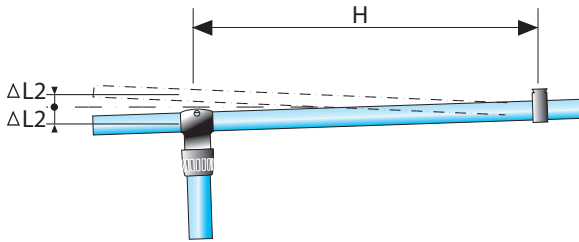

Ø	H (m)	ΔL2 maxi (mm)	ΔL3 maxi (mm)
63	1,5	13	26

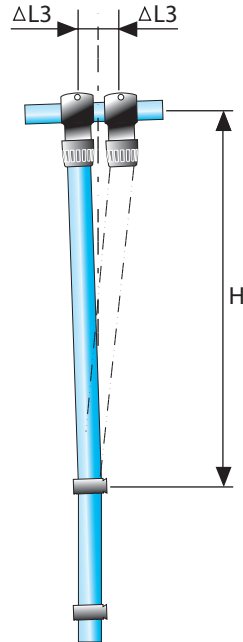



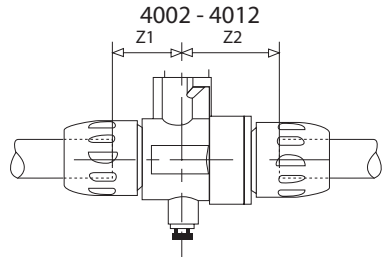
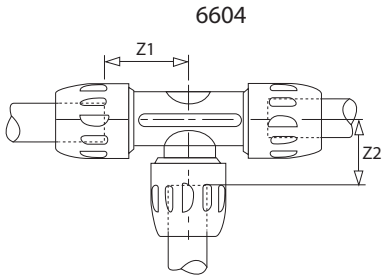
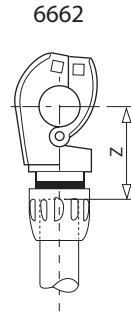
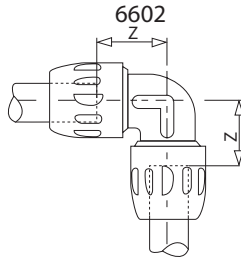
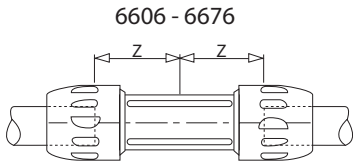

	Z	Z1	Z2
4002 63 00	-	84	98
4012 63 00	-	84	98
6602 63 00	61	-	-
6604 63 00	-	61	61
6604 63 40	-	61	116,0
6606 63 00	25	-	-
6662 63 25	75	-	-
6676 63 00	25	-	-

Z, Z1, Z2 = mm